

ALAN M. ARAKAWA
Mayor

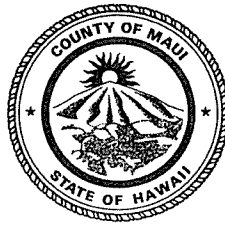

PATRICK K. WONG
Corporation Counsel

EDWARD S. KUSHI
First Deputy

LYDIA A. TODA
Risk Management Officer
Tel. No. (808) 270-7535
Fax No. (808) 270-1761

DEPARTMENT OF THE CORPORATION COUNSEL
COUNTY OF MAUI
200 SOUTH HIGH STREET, 3RD FLOOR
WAILUKU, MAUI, HAWAII 96793
EMAIL: CORPCOUN@MAUICOUNTY.GOV
TELEPHONE: (808) 270-7740
FACSIMILE: (808) 270-7152

RECEIVED
2018 JUL 23 PM 4: 21
OFFICE OF THE
COUNTY COUNCIL

July 23, 2018

MEMO TO: Yuki Lei K. Sugimura, Chair
Policy, Economic Development and Agriculture Committee

FROM: Richelle Thomson, Deputy Corporation Counsel

SUBJECT: **AUTHORIZING AN AMENDMENT TO EXTEND THE TERM AND
MODIFY CONDITIONS RELATING TO REMOVAL OF EQUIPMENT
FOR THE GRANT OF A LICENSE OF COUNTY REAL PROPERTY FOR
ELECTRIC VEHICLE QUICK CHARGERS AND LOCAL BATTERY
UNITS (PEA 70)**

Please find attached a revised proposed ordinance for the committee's consideration.

LF2016-0312

Resolution

No. _____

AUTHORIZING AN AMENDMENT TO EXTEND THE TERM AND MODIFY
CONDITIONS RELATING TO REMOVAL OF EQUIPMENT FOR THE GRANT OF A
LICENSE OF COUNTY REAL PROPERTY FOR ELECTRIC VEHICLE QUICK
CHARGERS AND LOCAL BATTERY UNITS

WHEREAS, pursuant to authorization by County Council's Approval of County Resolution No 15-28, on December 17, 2014, the County and Hitachi Advanced Clean Energy Corporation ("HACEC") entered a license agreement to conduct the JUMP Smart Maui project, which included installing, operating and maintaining Electric Vehicle Quick Chargers and battery units for use by the public at Kihei Community Center, the Lahaina Aquatic Center, the Kalama Pakui Building, and the Haiku Community Center, hereinafter referred to as the "License Agreement," a copy of which is attached hereto as Exhibit "1"; and

WHEREAS, the License Agreement was amended by the First Amendment thereto, a copy of which is attached hereto as Exhibit "2"; and

WHEREAS, through the proposed Second Amendment, attached hereto as Exhibit "3", the Parties to the License Agreement desire to extend the term of the Agreement to March 31, 2020, and make other modifications of the agreement, including a proposed release payment to the County in lieu of requiring removal of the equipment at the end of the term; and

Resolution No. _____

WHEREAS, the Council of the County of Maui may authorize an Amendment to the License Agreement for use of County real property pursuant to Chapter 3.36, Maui County Code by resolution.

NOW, THEREFORE, BE IT RESOLVED by the Council of the County of Maui:

1. That pursuant to Chapter 3.36, Maui County Code, the Second Amendment to the License Agreement, Exhibit "3", is hereby authorized; and
2. That the Mayor and the Director of Finance or their authorized representatives may execute the Second Amendment to the License Agreement; and
3. That certified copies of this Resolution be transmitted to the Mayor, the Director of Finance, and the HACEC.

APPROVED AS TO FORM
AND LEGALITY:

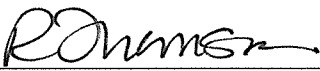

Jerrie Sheppard
Deputy Corporation Counsel
County of Maui
2016-0312
2018-07-23 Resolution (Second Amendment)

ELECTRIC VEHICLE QUICK CHARGER AND LOCAL BATTERY LICENSE AGREEMENT

Effective as of December 17, 2014 (the "Effective Date"), and for good and valuable consideration, the receipt of which is hereby acknowledged the COUNTY OF MAUI, a political subdivision of the State of Hawaii ("Licensor"), and HITACHI ADVANCED CLEAN ENERGY CORPORATION, a Hawaii corporation ("Licensee"), agree as follows (this "Agreement"):

1. **Background.** Licensor is the owner of the properties described in the attached Exhibit "A" (each a "Property"). Licensee and Licensor desire that Licensee have the right to use a portion of each Property to install, operate and maintain electric vehicle quick chargers at Properties 1-3 and to install, operate, and maintain three (3) local battery units at Property 4. This Agreement is part of the project implemented by Licensee ("JUMP Smart Maui project"). At each Property Licensee will be permitted to design and install the equipment described in Exhibit B under "Licensee's Facilities".

2. **License.** Licensor licenses to Licensee a certain portion of the Property as described in Exhibit A sufficient to install, operate and maintain Licensee's Facilities, together with all necessary space and easements for access and utilities to operate Licensee's Facilities, as generally described and depicted in attached Exhibit "B" (collectively, the "License Area"). This Agreement shall constitute a license coupled with an interest but shall not be deemed to grant, transfer, or convey to Licensee any real property interest in the Property.

3. **Term.** The term of this Agreement shall commence on the Effective Date and end on March 31, 2016.

4. **Permitted Use.** The License Area may be used by Licensee for electric vehicle quick charger stations that are available for use by the public; local battery units; and for the installation, operation and maintenance of Licensee's Facilities and related activities. Licensee shall obtain, at Licensee's expense, all licenses and permits required for installation of Licensee's Facilities and Licensee's use of the License Area from all applicable government or regulatory entities (the "Governmental Approvals") and may obtain a title report, perform surveys, soils tests, and other engineering procedures on, under and over the Property, necessary to determine that Licensee's use of the License Area will be compatible with Licensee's engineering specifications, system, design, operations and Governmental Approvals. Licensor agrees to reasonably cooperate with Licensee (at no cost to Licensor), where required, to perform such investigations or obtain Governmental Approvals.

5. **Improvements; Utilities; Access.**

(a) Licensee shall have the right, at its expense, to install, operate and maintain Licensee's Facilities on the License Area. Licensee's Facilities shall be initially configured generally as depicted in Exhibit "B". Licensee shall have the right to replace or upgrade Licensee's Facilities at any time during the term of this Agreement so long as the "footprint" of the License Area does not expand. Licensee shall cause all construction to occur lien-free and in compliance with all applicable laws and ordinances. Licensee's Facilities shall remain the exclusive responsibility of Licensee. Licensee shall remove Licensee's Facilities upon termination of this Agreement unless prior to such date mutually agreeable arrangements have been made for continued use of the property once the JUMP Smart Maui project has ended.

EXHIBIT " 1 "

(b) Licensee shall not commence the installation of Licensee's Facilities, or make any alterations or upgrades until Licensee submits the plans and specifications for Licensee's Facilities, or alterations or upgrades, to Licensor and Licensor approves such plans and specifications. If Licensor does not approve or disapprove of such plans and specifications within 10 (ten) business days after receipt, such plans and specifications shall be deemed approved. Licensor shall not unreasonably withhold or delay its approval of such plans and specifications.

(c) Licensee shall, at Licensee's expense, keep and maintain the License Area in commercially reasonable condition and repair during the term of this Agreement, normal wear and tear excepted. Upon termination of this Agreement, the License Area shall be returned to Licensor in good, usable condition, normal wear and tear excepted.

(d) Licensee shall have the right, at Licensee's expense, to install and maintain utilities and to improve the present utilities to the License Area (including, but not limited to the installation of overhead or underground utility lines, cables, conduits, transformers, wires, meters, monitoring equipment and other necessary equipment to connect Licensee's Facilities to utility sources located on the Property). If there are sufficient utility sources located on the Property to operate Licensee's Facilities, Licensee shall have the right to connect to such sources at Licensee's expense; provided, however, that Licensee shall cause its use of such utility sources to be separately metered and nothing will be charged to Licensor. If there are not sufficient utility sources located on the Property to operate Licensee's Facilities, Licensor agrees to grant to Licensee or the local utility provider the right to install such utilities on, over, under and through the Property as necessary for Licensee to operate Licensee's Facilities, at Licensee's expense; provided, however, (i) the location of such utilities shall be as reasonably designated by the mutual agreement of Licensor and Licensee, (ii) for Property 2, Licensee shall cause its use of such utility sources to be separately metered and billed directly to Licensee by the applicable utility provider, and (iii) at Properties 1, 3, and 4, Licensee shall install a submeter to track the amount of electricity used by Licensee's Facilities and shall reimburse Licensor for the costs of electricity used.

(e) During the term of this Agreement, Licensee and its employees, agents, contractors, customers and other invitees shall have a non-exclusive right of ingress and egress from a public right-of-way in and through the Property to and from the License Area

6. Interference. Licensee shall not use the License Area in any way which interferes with the use of the Property by Licensor, or tenants or licensees of Licensor, with rights in the Property prior in time to Licensee's rights. Similarly, Licensor shall not use, nor shall Licensor permit its tenants, licensees, employees, invitees or agents to use any portion of the Property in any way which interferes with the operations of Licensee.

7. Taxes. Licensee will pay any personal property taxes assessed on, or any portion of such taxes attributable to, Licensee's Facilities. Licensor shall pay when due all real property taxes and all other fees and assessments attributable to the Property.

8. Termination.

(a) This Agreement may be terminated without any penalty or further liability upon thirty (30) days written notice by Licensor if Licensee defaults and fails to cure such default within that 30-day period, or such longer period as may be required to diligently complete a cure commenced within that 30-day period.

(b) If Licensor intends to develop any portion of its lands for the erection of buildings or other improvements with which License Area will interfere, then Licensor shall so notify Licensee in writing at least four (4) months prior to such development and Licensee shall thereafter have the right to terminate this Agreement or have the right to be licensed another portion of the property.

9. **Insurance and Subrogation.** Licensee will provide Commercial General Liability Insurance in an aggregate amount of \$2,000,000 and name Licensor as an additional insured on the policy or policies. Licensee may satisfy this requirement by obtaining appropriate endorsement to any master policy of liability insurance Licensee may maintain.

10. **Indemnification.** Licensee will indemnify and hold Licensor (including without limitation visitors and invitees to Lessor's facilities) harmless from and against all claims and demands for loss or damage, including but not limited to reasonable attorneys' fees and costs (collectively, "Claims"), arising out of, or in connection with this Agreement.

11. **Notices.** All notices, requests, demands and other communications under this Agreement shall be in writing and shall be deemed given if personally delivered or mailed, certified mail, return receipt requested, or sent by overnight carrier to the following addresses:

If to Licensee, to:	with a copy to:
Hitachi Advanced Clean Energy Corporation Attention: Takenori Hatanaka 285 W. Kaahumanu Avenue, Suite 102, Kahului, HI 96732 Phone: (808) 868-4673	_____ _____ _____

If to Licensor, to:	with a copy to:
Managing Director County of Maui 200 South High Street Wailuku, HI 96793	_____ _____ _____

12. **Hazardous Materials.** Licensee shall not permit any of its employees, agents, contractors, or any other person to use, handle, discharge, release, dispose of or allow to exist on, within, under or about the License Area any Hazardous Materials (defined below) in violation of any Hazardous Materials Laws (defined below). In addition to the Indemnity obligations in Section 10 above, Licensee shall indemnify Licensor from and against all Claims directly arising out of or attributable to the release, threatened release, or disposal of Hazardous Materials on, under or about the License Area by Licensee. The term "Hazardous Materials" means any flammable explosives, radioactive materials, asbestos, organic compounds known as polychlorinated biphenyls, chemicals known to cause cancer or reproduction toxicity, pollutants, contaminants, hazardous wastes, toxic substances or related materials, including, without limitation, any substances defined as or included in the definition of "hazardous substances," "hazardous wastes," "hazardous materials," or "toxic substances" under any Hazardous Materials Laws. The term "Hazardous Materials Laws" means any federal, state or local laws, ordinances or regulations, now or hereafter in effect, relating to environmental conditions, industrial hygiene or Hazardous Materials on, under or about the License Area. Licensee's obligations under this Section shall survive termination of this Agreement.

13. Condemnation. If all or any portion of the License Area shall be taken or condemned by any authority having the power of eminent domain, then all compensation and damages payable for the fee interest in the License Area shall be paid to Licensor without any apportionment to Licensee, provided that Licensee shall be separately be entitled to seek recovery from the condemning authority for compensation for loss of Licensee's Facilities and its license and any related severance and relocation damages.

14. Assignment. Licensee may otherwise assign this License only upon written approval of Licensor, which approval shall not be unreasonably delayed or withheld.

15. Personal property determination. Licensor hereby waives any right to claim that Licensee's Facilities have become real property, either as fixtures, business chattel or otherwise, it being the intent of the parties that Licensee's Facilities are the personal property of Licensee regardless of any installation on a Property. Licensee has the right to remove all or any portion of the same from time to time, whether before or after a default under this License, in Licensee's sole discretion and without Licensor's consent.

16. Miscellaneous.

(a) The covenants contained herein shall inure to the benefit of and be binding upon, the parties and their respective heirs, personal representatives, beneficiaries, successors, successors in trust and assigns.

(b) This Agreement constitutes the entire agreement and understanding of the parties regarding the subject matter of this Agreement, and supersedes all offers, negotiations and other agreements. There are no representations or understandings of any kind not set forth in this Agreement. Any amendments to this Agreement must be in writing and executed by both parties.

(c) This instrument shall be governed, interpreted, construed and regulated by the laws of the State of Hawaii, excluding its choice of law rules that may otherwise require the application of the law of another jurisdiction.

(e) If any term of this Agreement is found to be void or invalid, such invalidity shall not affect the remaining terms of this Agreement, which shall continue in full force and effect. The parties intend that the provisions of this Agreement be enforced to the fullest extent permitted by applicable law. Accordingly, the parties agree that if any provisions are deemed not enforceable, they shall be deemed modified to the extent necessary to make them enforceable.

(f) The persons who have executed this Agreement represent that they are duly authorized to execute this Agreement in their individual or representative capacity as indicated.

(g) The paragraph headings included herein are for convenience only and shall not be construed to limit or expand the content of such paragraphs.

(h) This Agreement may be executed in any number of counterpart copies, each of which shall be deemed an original, but all of which together shall constitute a single instrument.

IN WITNESS WHEREOF, the parties hereto have executed this Agreement as of the date first above written.

APPROVAL RECOMMENDED:

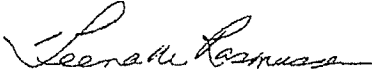

TEENA M. RASMUSSEN
Economic Development Director

APPROVED AS TO FORM

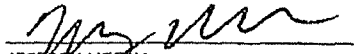

JEFFREY UEOKA
Deputy Corporation Counsel
County of Maui

OED.Hitachi_License Agmt.10.22.14.docx

COUNTY OF MAUI



ALAN M. ARAKAWA
Its Mayor



DANILO F. AGSALOG
Its Director of Finance

HITACHI ADVANCED CLEAN ENERGY
CORPORATION

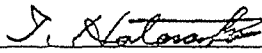
By 

TAKENORI HATANAKA
Its Vice President

EXHIBIT "A"

DESCRIPTION OF THE PROPERTY

Property 1. Parking lot in front of Kalana O Maui 200 South High St.

Property 2. Parking lot at the Haiku Community Center

Property 3 Parking lot at the Lahaina Aquatic Center

Property 4 Machine room at the Kihei Aquatic Center

EXHIBIT "B"

LICENSEE'S FACILITIES:

Licensee' Electric Vehicle Charging Stations shall have a maximum of 4 charging ports at one location. Licensor and licensee shall agree the number of charging ports to install at Properties 1 - 3.

Properties 1-3: Electric Vehicle Charging Stations that are UL listed, and designed and installed in compliance with the applicable Electric Code. Each charging station to have at least two charging ports that comply with the ChaDeMo Standard, at least one Level II charging port that meets SAE J 1772, and by the end of the JUMP Smart Maui test, at least two additional fast charging ports that meet SAE Level 3 standards or such other fast charge standard as Licensee agree to. The parties presently anticipate that Combo CCS units will be provided but recognize that the technology is rapidly changing. Each charging station will contain a telecommunication device called a micro DMS. All electrical use for the EV charging station shall be via a dedicated meter and Licensee shall be solely responsible for the cost of all electricity used by the EV charging station.

Property 4. Local battery system including the telecommunication device micro DMS that will be used as part of the JUMP Smart Maui system. Licensee shall further discuss with Licensor the possibility of utilizing the local battery system for emergency use at the Licensor's facilities.

DESCRIPTION OF THE LICENSE AREA AND SITE PLAN

HITACHI TO PROVIDE

Exhibit A (Property 1)

Electric Vehicle Charging Station Project for : County of Maui

KALANA PAKUI BUILDING AND PARKING
250 S. HIGH STREET WAILUKU MAUI HI 96732
T.M.K. : (2) 3 - 4 - 008 : 042

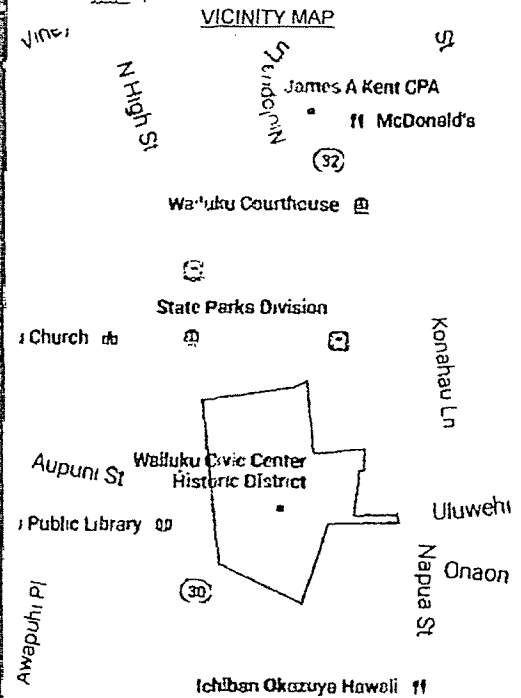
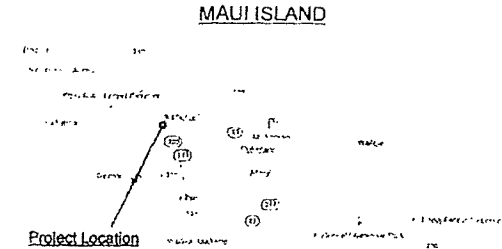
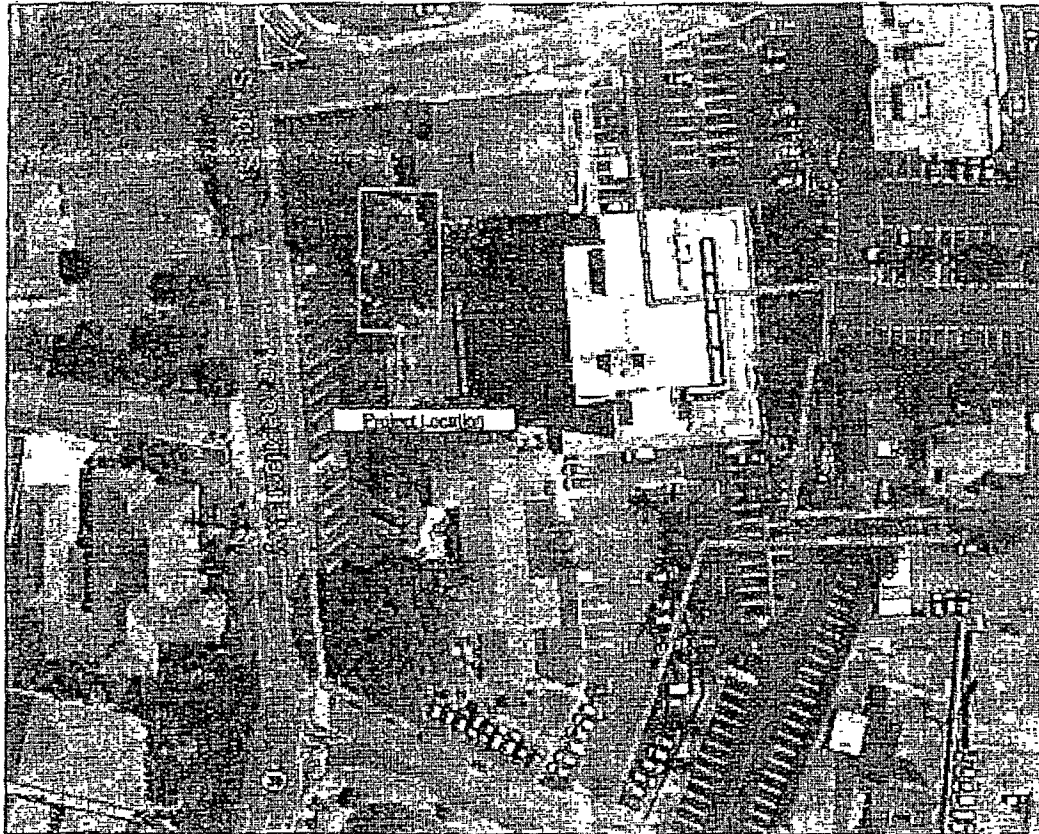

REV	DESCRIPTION	DATE
0	Drawing	10/15/2014
	REVISIONS	

TITLE	Location	REV
Exhibit A (Property 1)	County Building	

Exhibit B (Property 1)

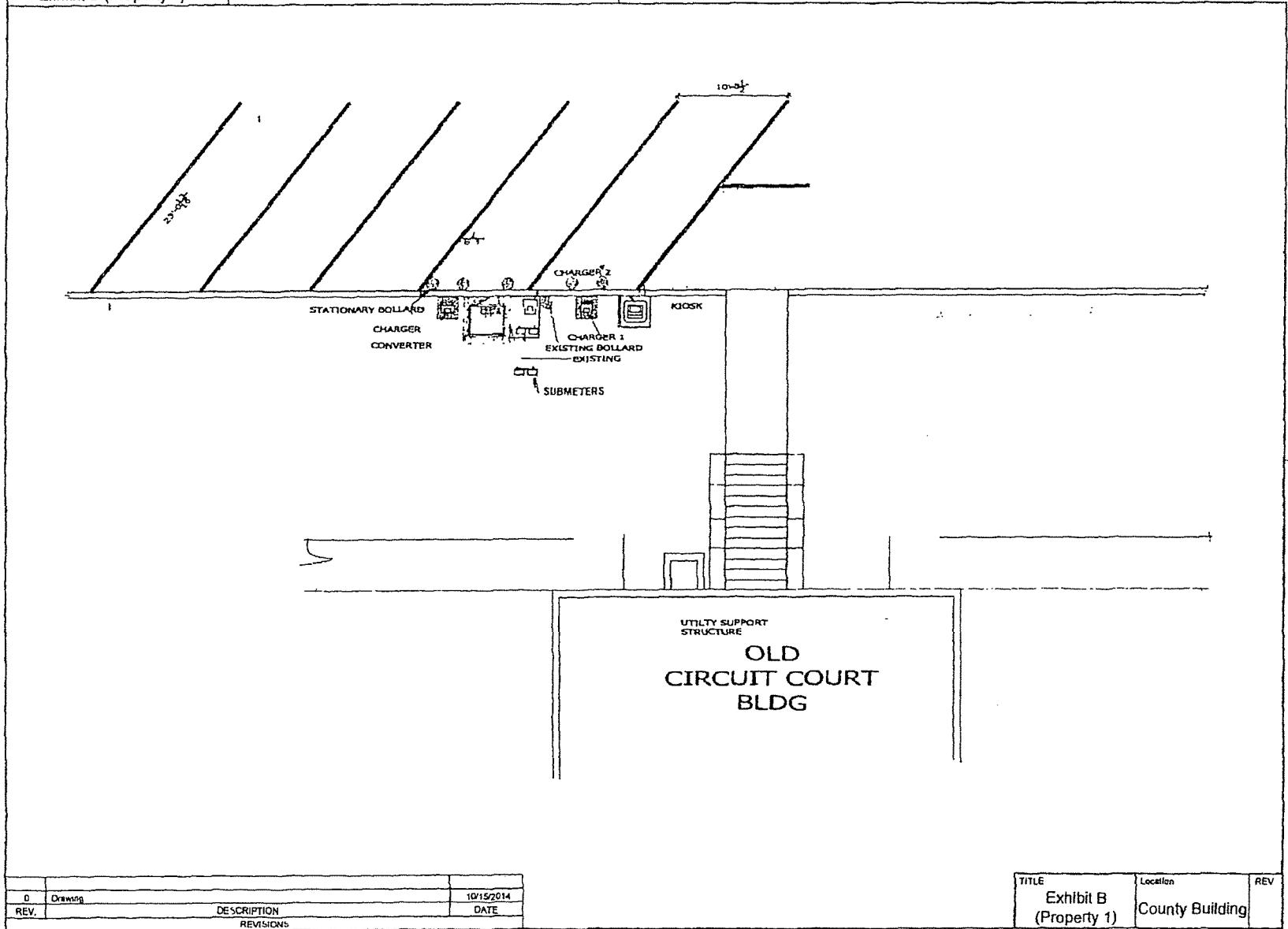
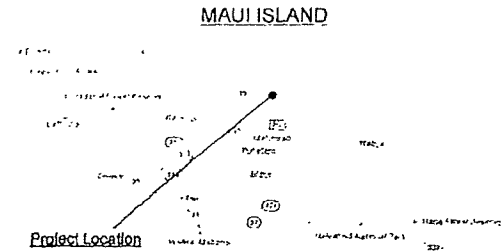
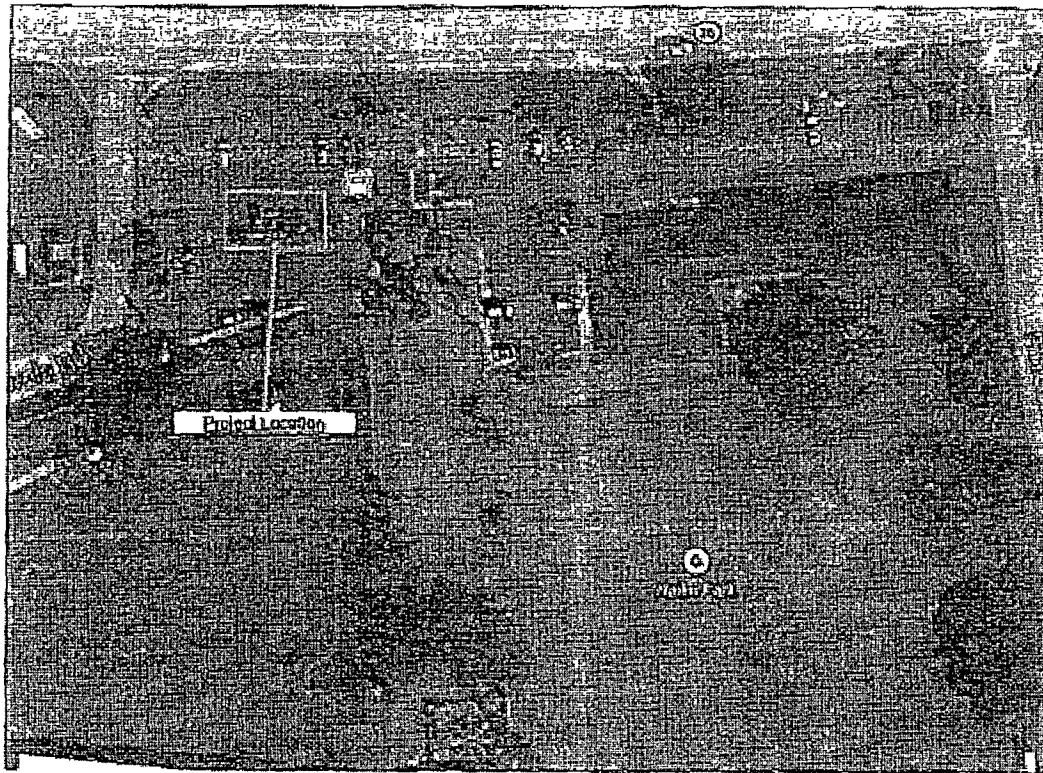

Exhibit A (Property 2)

Electric Vehicle Charging Station Project for : Haiku Community Center

2830 HANA HWY, HAIKU, HI 96708
T.M.K. : (2) 2 - 7 - 004 : 029



VICINITY MAP

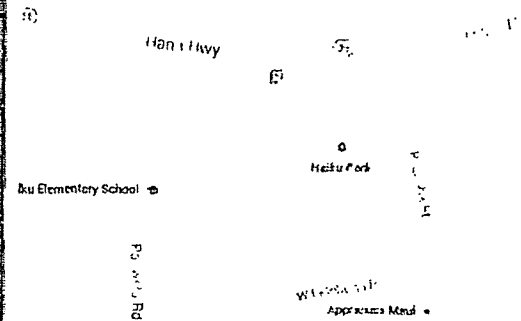

Q	Drawing	10/15/2014
REV	DESCRIPTION	DATE
	REVISIONS	

TITLE	Location	REV
Exhibit A (Property 2)	Haiku Community Center	

Exhibit B (Property 2)

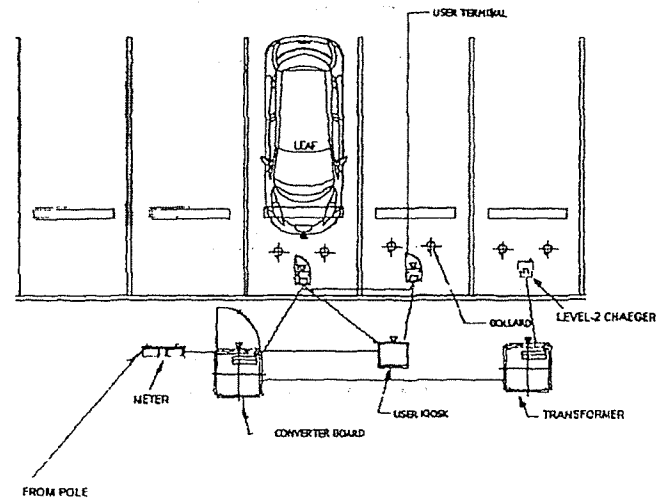
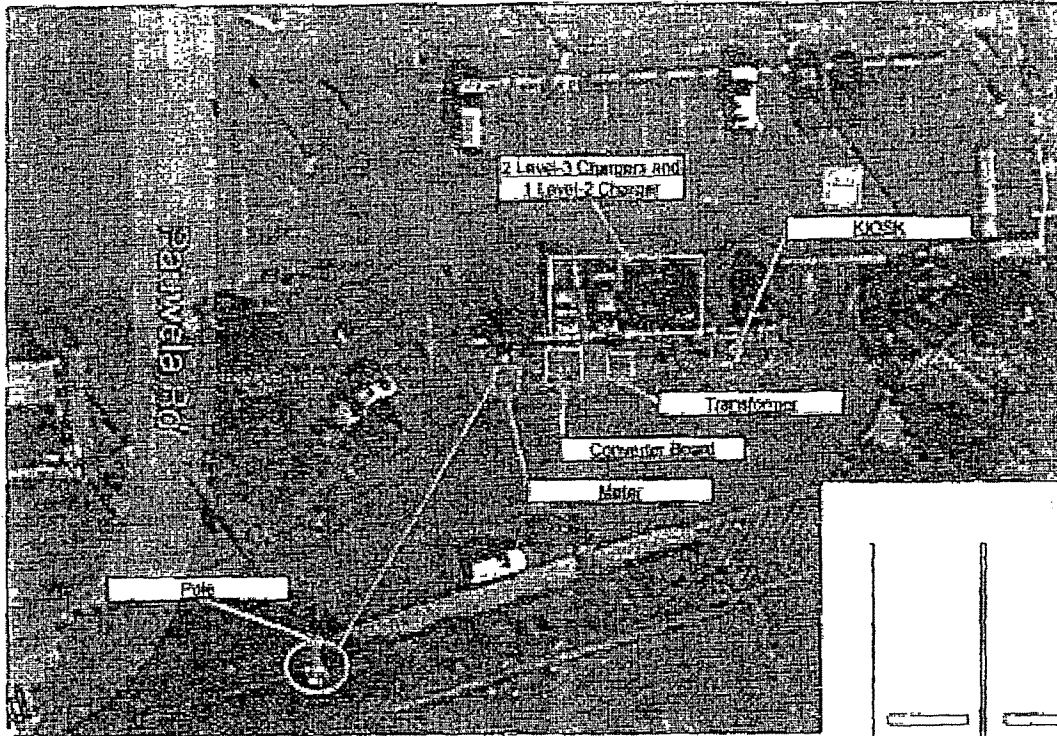

0	Drawing	10/16/2014
REV	DESCRIPTION	DATE
	REVISIONS	

TITLE	Location	REV
Exhibit B (Property 2)	Haiku Community Center	

Exhibit A (Property 3)

Electric Vehicle Charging Station Project for : Lahaina Aquatic Center

245 SHAW STREET, LAHAINA HI 96761
T.M.K. : (2) 4 - 6 - 012 : 005

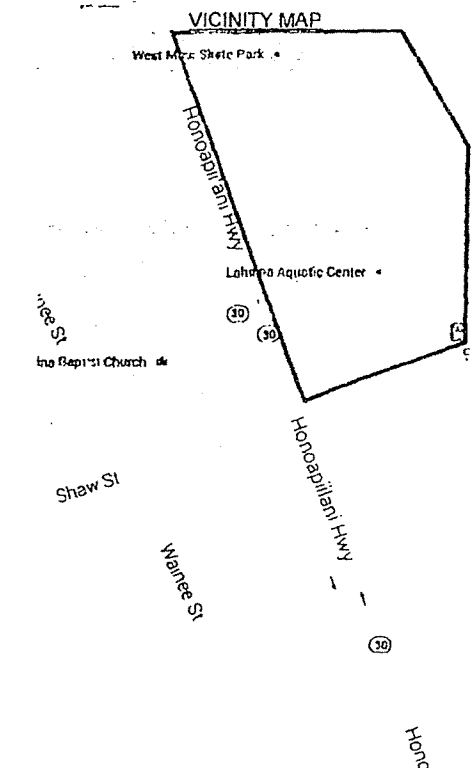
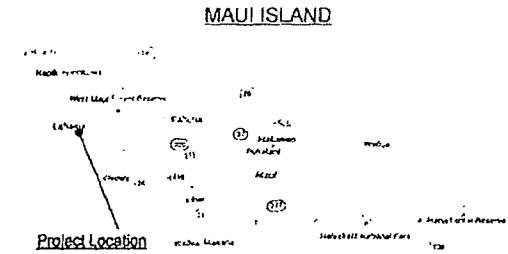
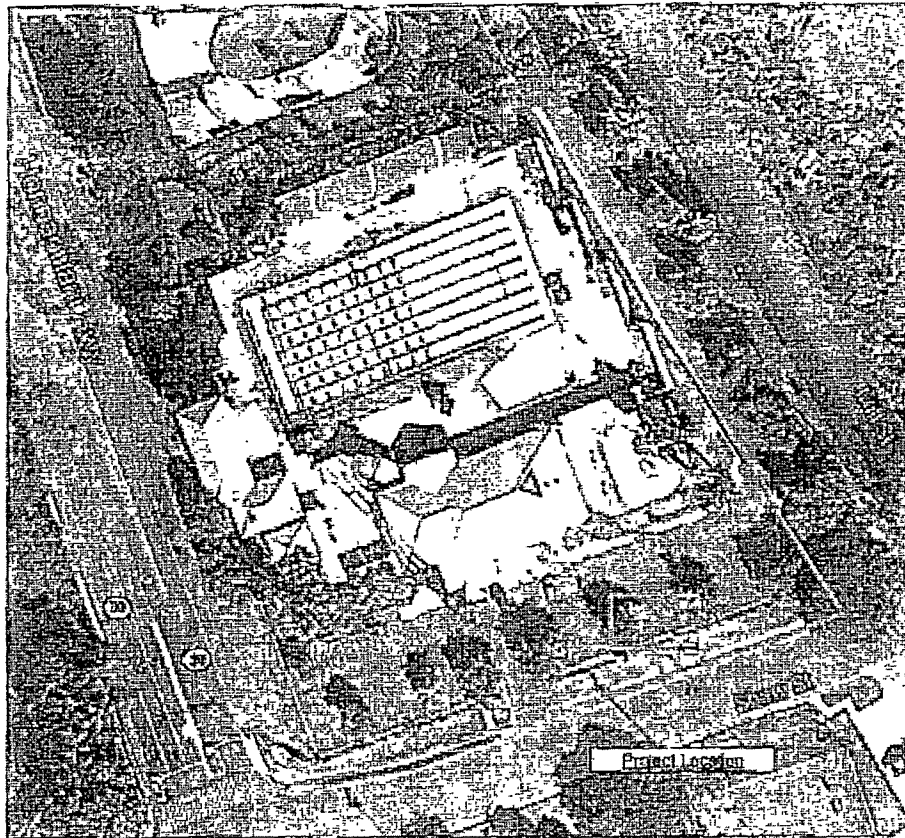

REV.	DESCRIPTION	DATE
0	Drawings	10/15/2014
REVISIONS		

TITLE	Location	REV
Exhibit A (Property 3)	Lahaina Aquatic Center	

Exhibit B (Property 3)

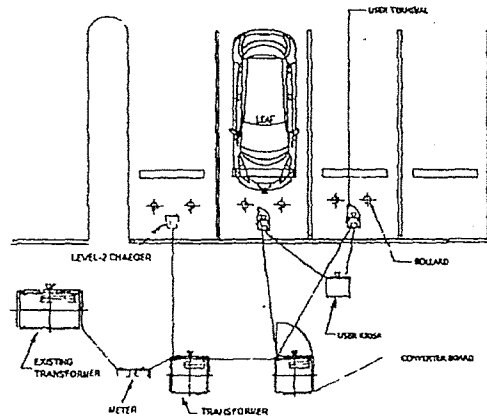
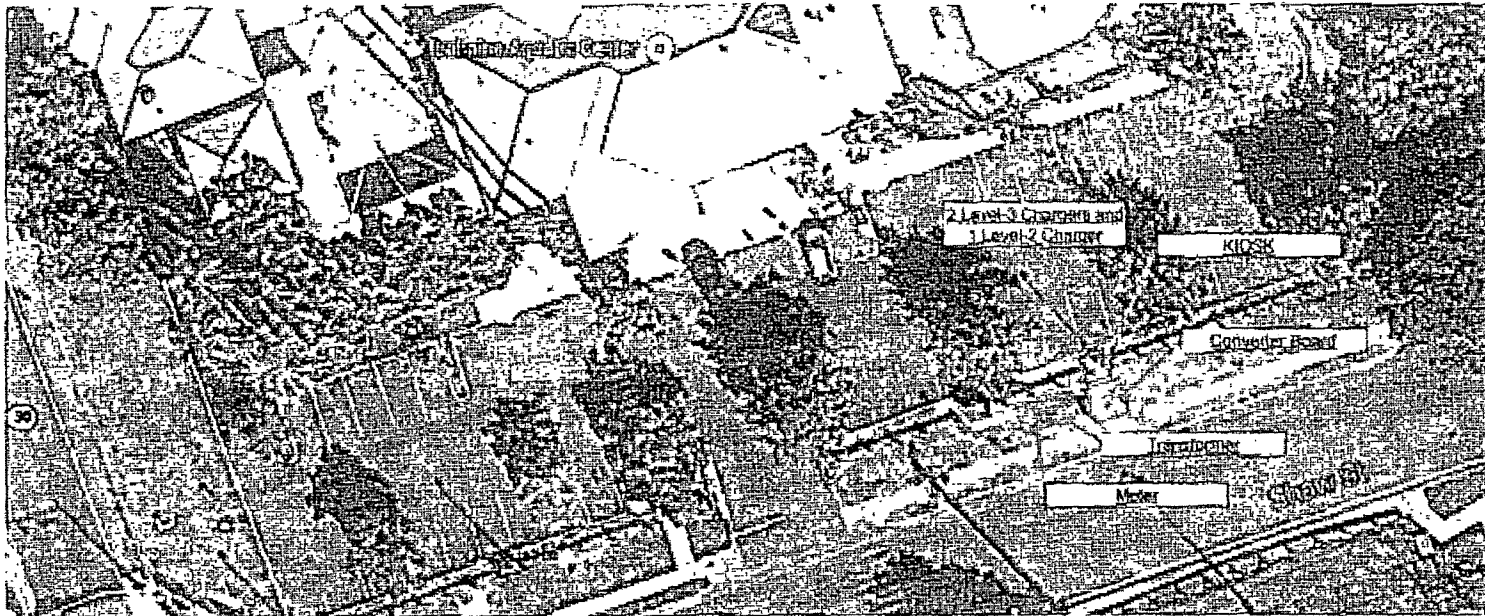

0	Drawing	10/15/2014
REV	DESCRIPTION	DATE
	REVISIONS	

TITLE	Location	REV
Exhibit B (Property 3)	Lahaina Aquatic Center	

Exhibit A (Property 4)

HITACHI
 SUNVERGE INSTALLATION
 DEMONSTRATION PROJECT
 KIHEI COMMUNITY CENTER
 303 E LIPOA ST
 KIHEI, HI 96753

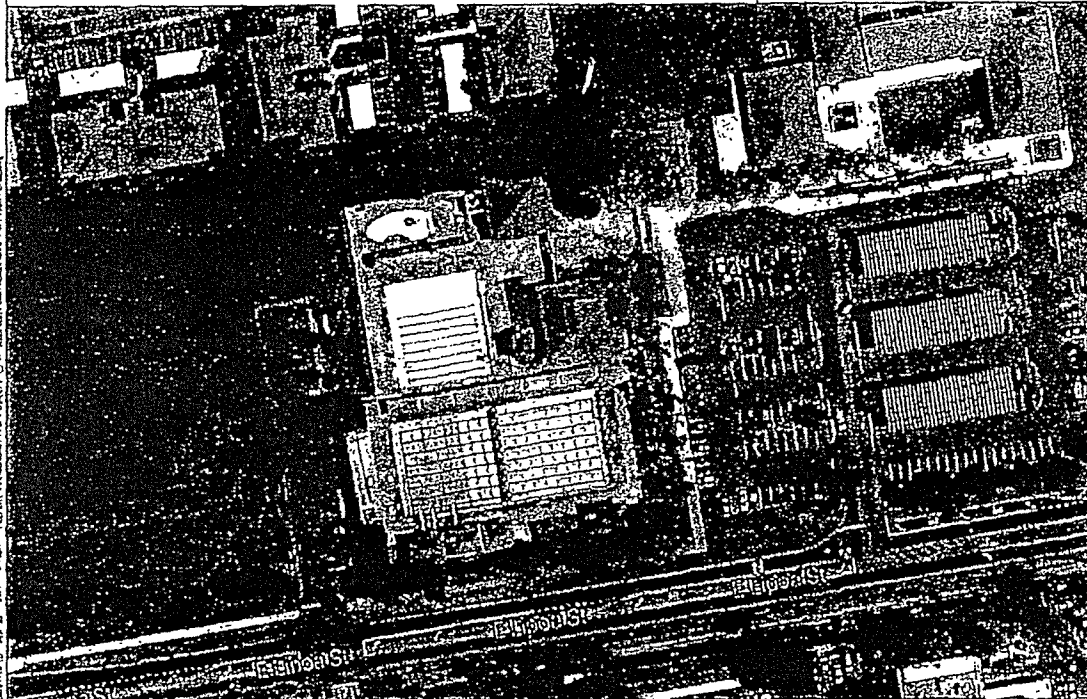
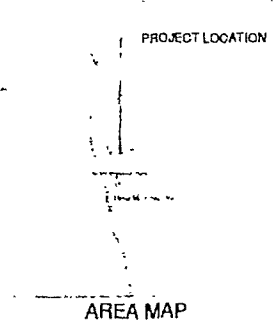
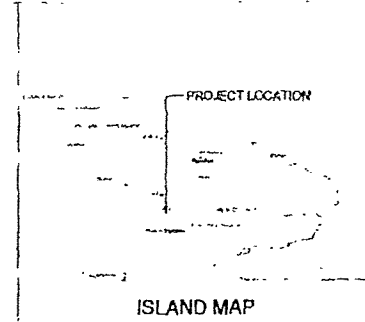

DRAWING INDEX

COVERSHEET	E-1
SITE PLAN	E-2
ONE LINE	E-3
DETAILS	E-4
DATASHEET	E-5

SUNVERGE
 DEMONSTRATION
 AND INSTALLATION

HNU ENERGY
 Honoring the Power of Light
 and Passion to the 4
 Corners of the World
 1000 Kalia Road, Suite 1000
 Honolulu, HI 96813
 www.hnuenergy.com

This document is prepared by the contractor for the use of the client. It is not to be used for any other purpose without the written consent of the contractor.

HITACHI
 SUNVERGE INSTALLATION
 DEMONSTRATION PROJECT
 KIHEI COMMUNITY CENTER
 303 E LIPOA ST
 KIHEI, HI 96753

PROJECT TITLE
 Exhibit A
 (Property 4)

REVISIONS

NOT FOR CONSTRUCTION
 UNLESS SO SPECIFICALLY NOTED

DESIGNED BY: DK
 DRAWN BY: MHP
 JOB NO:
 DATE: 2/20/12
 SHEET
 E-1
 SHEET NO. 1 OF 1

Exhibit B (Property 4)

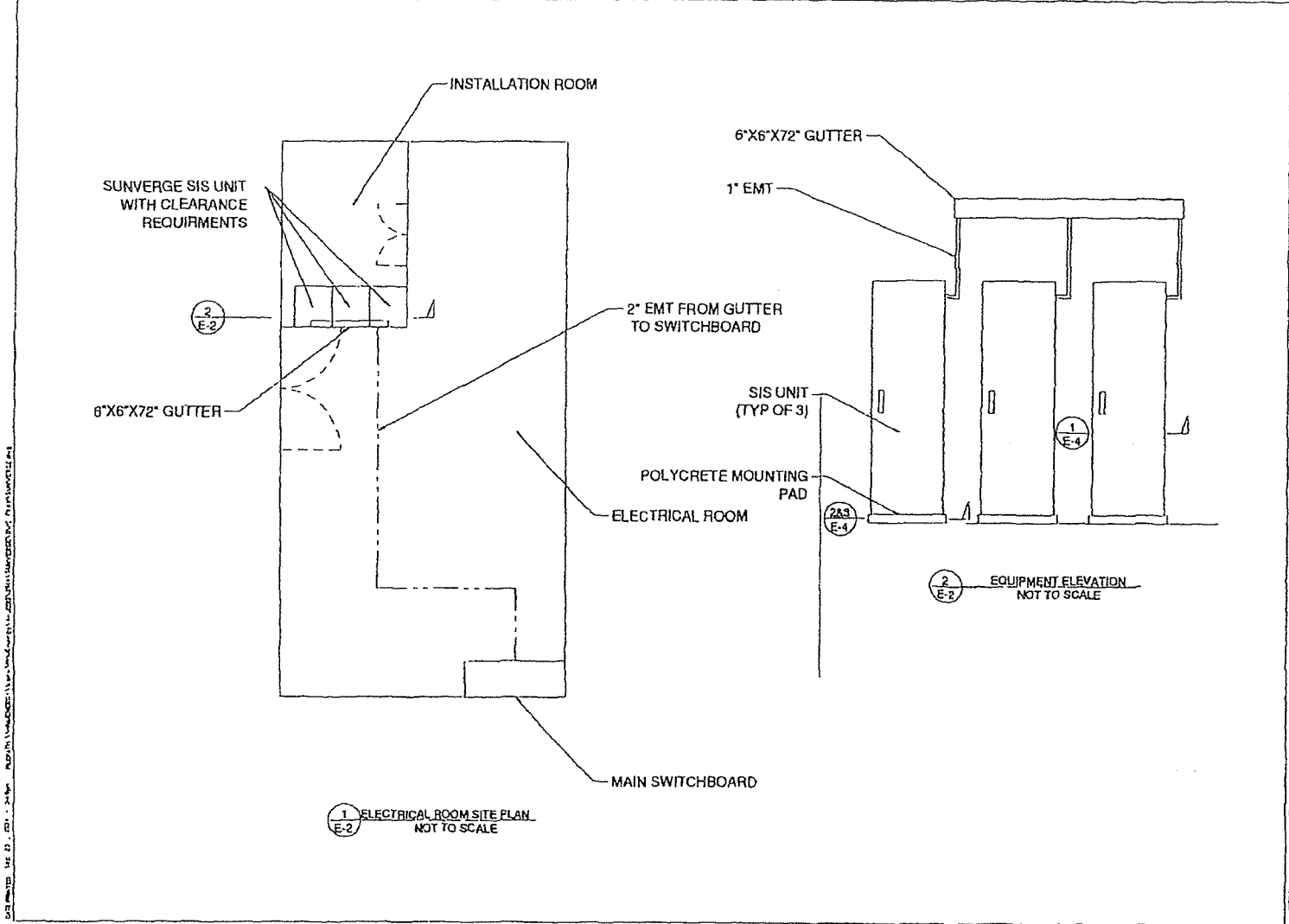

SUNVERGE
DISTRIBUTION
INSTALLATION



This work was prepared by the author
for the sole use and benefit of the
client and is not to be distributed
outside of the client's organization.

PROJECT TITLE:
HITACHI
SUNVERGE DISTRIBUTION
DEMONSTRATION PROJECT
KIHEI COMMUNITY CENTER
301E LIPOA ST.
KIHEI, HI 96753

SHEET TITLE:
Exhibit B
(Property 4)

KEYWORDS:
NOT FOR CONSTRUCTION
LARGER AS SHOWN/NOTION NET
DESIGNED BY: DK
DRAWN BY: MR
JOB NO.:
DATE: 09/20/12
SHEET:
E-2
SHEET NO. OF 2

FIRST AMENDMENT TO ELECTRIC VEHICLE QUICK CHARGER AND
LOCAL BATTERY LICENSE AGREEMENT

THIS FIRST AMENDMENT TO LICENSE AGREEMENT, effective the
19 day of July, 2016, by and between HITACHI
ADVANCED CLEAN ENERGY CORPORATION, a Hawaii corporation
("LICENSEE"), whose address is 285 West Kaahumanu Avenue, Suite
102, Kahului, Hawaii 96732, and the COUNTY OF MAUI, a political
subdivision of the State of Hawaii, whose principal place of
business is 200 South High Street, Wailuku, Maui, Hawaii 96793,
hereinafter called the "LICENSOR" and collectively called the
"PARTIES".

W I T N E S S E T H:

WHEREAS, the PARTIES entered into that certain Electric
Vehicle Quick Charger and Local Battery License Agreement (the
"License Agreement"), dated December 17, 2014, on file with the
Director of Finance and incorporated herein by reference,
providing four property sites to be used by Licensee for electric
vehicle quick charge stations available for public use; local
battery units, and installation, operation and maintenance of
Licensee's facilities and related activities, at (1) the parking
lot in front of Kalana O Maui, 200 South High Street, Wailuku; (2)
the parking lot at the Haiku Community Center; (3) the parking lot

EXHIBIT " 2 "

at the Lahaina Aquatic Center; and (4) the machine room at the
Kihei Aquatic Center; and

WHEREAS, the parties desire to amend the License Agreement
to provide for an extension of the Term of the License Agreement.

NOW, THEREFORE, for and in consideration of the mutual
promises set forth herein, the parties hereby agree to amend
Paragraph 3. Term, of the License Agreement in its entirety to
read as follows:

"3. Term. The term of this Agreement shall
commence on the Effective Date and end on March 31,
2018."

All other terms and conditions as provided in the License
Agreement shall continue in full force and effect.

IN WITNESS WHEREOF, the parties hereto have executed this
Agreement the day, month and year first above written.

LICENSEE:

HITACHI ADVANCED CLEAN ENERGY
CORPORATION

By 

BY FUMITOSHI EMURA
(Signature)

Print Name: _____

its President

Title

July 21, 2016

By _____
(Signature)

Print Name: _____

Its _____
(Title)

COUNTY OF MAUI:

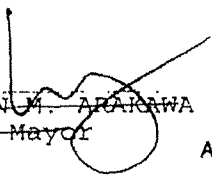
By 
~~ALAN M. APARAWA~~
~~Its Mayor~~

KEITH A. REGAN
ACTING MAYOR, COUNTY OF MAUI

APPROVAL RECOMMENDED:

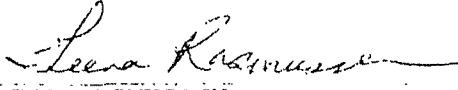
TEENA RASMUSSEN
Director, Office of
Economic Development

SAMANDA K. BAZ
Budget Director

APPROVED AS TO FORM
AND LEGALITY:

JERRY L. SHEPPARD
Deputy Corporation Counsel
County of Maui
2016 0312

NOTARIAL CERTIFICATE

This is to certify that FUMITOSHI EMURA, who is President of HITACHI ADVANCED CLEAN ENERGY CORPORATION, affixed his signature in my very presence to the attached document.

Dated this 21st day of July, 2016.

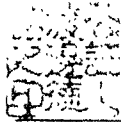

N. Watanabe

Noriaki Watanabe

NOTARY

3-1, Marunouchi 3-chome,

Chiyoda-ku, Tokyo, Japan

ATTACHED TO

TOKYO LEGAL AFFAIRS BUREAU

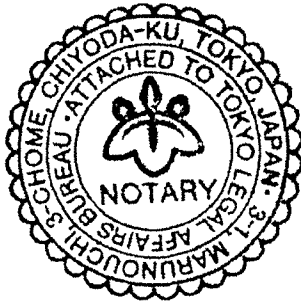

2016.7.21

平成28年登簿第 1679 号

認 証

HITACHI ADVANCED CLEAN ENERGY CORPORATIONのPresident江村文敏 (FUMITOSHI EMURA) は、当職の面前で、添付書面に自ら署名した。以下余白

よって、これを認証する

平成28年 7 月 21 日、本公証人役場において

東京都千代田区丸の内三丁目3番1号

東京法務局所 属

公 証 人

Notary

渡邊 徳 昭

NORIAKI WATANABE

証 明

上記署名は、東京法務局所属公証人の署名に相違ないものであり、かつ、その押印は、
真実のものであることを証明する

平成28年 7 月 21 日

東京法務局長

佐藤 主税

APOSTILLE

(Convention de La Haye du 5 octobre 1961)

1. Country: JAPAN
This public document
2. has been signed by NORIAKI WATANABE
3. acting in the capacity of Notary of the Tokyo Legal Affairs Bureau
4. bears the seal/stamp of NORIAKI WATANABE, Notary

Certified

5. at Tokyo
6. Jul.21.2016
7. by the Ministry of Foreign Affairs
8. 16NE346702
9. Seal/stamp
10. Signature

A. Ogawa

Ayako OGAWA

For the Minister for Foreign Affairs

STATE OF HAWAII)
) SS.
COUNTY OF MAUI)

On this 25th day of January, 2017, before me appeared ~~ALAN M. ARAKAWA~~ ^{Kelii P. Nahookaika}, to me personally known, who being by me duly sworn did say that he is the Mayor of the County of Maui, a political subdivision of the State of Hawaii, in the capacity shown, having been duly authorized to execute such instrument in such capacity, and that the seal affixed to the foregoing instrument is the lawful seal of the said County of Maui, and that the said instrument was signed and sealed in behalf of said County of Maui by authority of its Charter, and the said ~~ALAN M. ARAKAWA~~ ^{Kelii P. Nahookaika} acknowledged the said instrument to be the free act and deed of said County of Maui.

IN WITNESS WHEREOF, I have hereunto set my hand and official seal.

[Stamp or Seal]

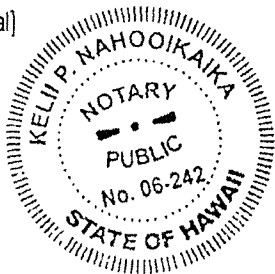

Kelii P. Nahookaika
Notary Public, State of Hawaii

Print Name: KELII P. NAHOOIKAIKA
My commission expires: 4.30.18

NOTARY PUBLIC CERTIFICATION

Doc Date: 7.19.16 # Pages: 6
Notary Name: KELII P. NAHOOIKAIKA Judicial Circuit: 2nd
Doc Description: amendment to electric vehicle
quick charger and local battery
licence agreement
Notary Signature: Kelii P. Nahookaika
Date: 1.25.17

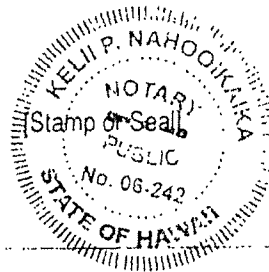

**SECOND AMENDMENT TO ELECTRIC VEHICLE QUICK CHARGER AND
LOCAL BATTERY LICENSE AGREEMENT**

THIS SECOND AMENDMENT TO LICENSE AGREEMENT, effective the _____ day of _____, 20____, by and between HITACHI ADVANCED CLEAN ENERGY CORPORATION, a Hawaii corporation ("LICENSEE"), whose address is 275 West Kaahumanu Avenue, Suite 1003, Kahului, Hawaii 96732, and the COUNTY OF MAUI, a political subdivision of the State of Hawaii, whose principal place of business is 200 South High Street, Wailuku, Maui, Hawaii 96793, hereinafter called the "LICENSOR" and collectively called the "PARTIES".

W I T N E S S E T H:

WHEREAS, the PARTIES entered into that certain Electric Vehicle Quick Charger and Local Battery License Agreement (the "License Agreement"), dated December 17, 2014, as amended by the FIRST AMENDMENT thereto, dated July 19, 2016, on file with the Director of Finance and incorporated herein by reference, providing four property sites to be used by Licensee for electric vehicle quick charge stations available for public use, local battery units, and installation, operation, and maintenance of Licensee's facilities and related activities, at (1) the parking lot in front of Kalana O Maui, 200 South High Street, Wailuku; (2) the parking lot at the Haiku Community Center; (3) the parking lot at the Lahaina Aquatic Center; and (4) the machine room at the Kihei Aquatic Center; and

EXHIBIT " 3 "

WHEREAS, the PARTIES desire to amend the License Agreement to provide for an extension of the Term of the License Agreement, to remove property (4) located at the Kihei Aquatic Center machine room from the License Agreement for the remaining term of the License Agreement as that equipment is no longer used and has been removed, and to provide additional exhibits showing the as-built conditions for the remaining properties (1) through (3) described in Exhibit "A" of the original License Agreement.

NOW, THEREFORE, for and in consideration of the mutual promises set forth herein, the parties hereby agree to amend the License Agreement as follows:

1. Property (4), pertaining to the machine room at the Kihei Aquatic Center, as detailed in Paragraph 1. and Exhibit "A" of the License Agreement, is hereby deleted from the License Agreement because that equipment is no longer used and has been removed. No further obligations are owed by either party with respect to Property (4).

2. Paragraph 3. of the License Agreement is amended in its entirety to read as follows:

"3. Term. The term of this Agreement shall commence on the Effective Date and end on March 31, 2020."

3. Paragraph 5. of the License Agreement, "Improvements; Utilities; Access," subsections (a) and (c) are amended in their entirety to read as follows:

"(a) Licensee shall have the right, at its expense, to install, operate and maintain Licensee's Facilities on the License Area. Licensee's Facilities shall be initially configured generally as depicted in Exhibit "B". Licensee shall have the right to replace or upgrade Licensee's Facilities at any time during the term of this Agreement so long as the "footprint" of the License Area does not expand. Licensee shall cause all construction to occur lien-free and in compliance with all the applicable laws and ordinances. Licensee's Facilities were donated to Maui Economic Development Board (MEDB) in 2016 and were leased by MEDB to Licensor for continued operations."

"(c) Licensee shall, at Licensee's expense, keep and maintain the License Area in commercially reasonable condition and repair during the term of this Agreement, normal wear and tear excepted."

4. Paragraph 5. of the License Agreement, "Improvements; Utilities; Access", is amended by adding the following new subsections (f) and (g), to read as follows:

"(f) In consideration of the terms set forth in this Second Amendment, Licensee shall pay to Licensor in readily available United States currency the amount of Ninety-eight thousand, six-hundred and fifty and no/100 Dollars, (\$98,650.00), hereinafter, the "Release Payment", within thirty days of final execution of this Second Amendment. In consideration of the Release Payment, Licensor hereby agrees to fully and forever release Licensee and MEDB (subject to subsection (g)) from any and all claims arising out of the License Agreement relating to the removal of the Facilities and/or the condition of Licensor's property (including, without limitation, the transferred Facilities) upon and after the termination of this License Agreement.

(g) Upon termination of this License Agreement, MEDB will transfer ownership of the Licensee's Facilities to Licensor. Should MEDB transfer or sell its interest in the Licensee's Facilities, MEDB will ensure this License Agreement's provisions pertaining to MEDB are incorporated into such transfer or sale to the receiving entity."

5. A new Paragraph 17. is added to the License Agreement to describe the "as-built" details of the EV charging systems, and shall read as follows:

"17. Current Conditions. Exhibits "C", "D", and "E", attached hereto, are hereby incorporated into the License Agreement to reflect the "as-built" details of the Facilities, i.e., the EV charging systems, at the three remaining property sites, specifically, Exhibit "C" reflects property (1), the parking lot in front of Kalana O Maui, 200 South High Street, Wailuku; Exhibit "D" reflects property (2), the parking lot at the Haiku Community Center; and Exhibit "E" reflects property (3), the parking lot at the Lahaina Aquatic Center."

All other terms and conditions as provided in the License Agreement shall continue in full force and effect.

IN WITNESS WHEREOF, the parties hereto have executed this Agreement the day, month and year first above written.

[REMAINDER OF PAGE INTENTIONALLY LEFT BLANK]
[SIGNATURE PAGES FOLLOW]

LICENSEE:

HITACHI ADVANCED CLEAN ENERGY
CORPORATION

By _____
(Signature)

Print Name: _____

Its _____
(Title)

By _____
(Signature)

Print Name: _____

Its _____
(Title)

[REMAINDER OF PAGE INTENTIONALLY LEFT BLANK]

STATE OF HAWAII)
) SS.
COUNTY OF MAUI)

On this _____ day of _____, 20____, before me personally appeared _____, to me personally known, who, being by me duly sworn or affirmed, did say that such person executed the foregoing instrument as the free act and deed of such person, and if applicable, in the capacity shown, having been duly authorized to execute such instrument in such capacity.

IN WITNESS WHEREOF, I have hereunto set my hand and official seal.

[Stamp or Seal]

Notary Public, State of Hawaii

Print Name

My commission expires: _____

NOTARY PUBLIC CERTIFICATION	
Doc. Date: _____	# Pages: _____
Notary Name: _____	Judicial Circuit: _____
Doc. Description: _____	

Notary Signature: _____	[Stamp or Seal]
Date: _____	

STATE OF HAWAII)
) SS.
COUNTY OF MAUI)

On this _____ day of _____, 20____, before me personally appeared _____, to me personally known, who, being by me duly sworn or affirmed, did say that such person executed the foregoing instrument as the free act and deed of such person, and if applicable, in the capacity shown, having been duly authorized to execute such instrument in such capacity.

IN WITNESS WHEREOF, I have hereunto set my hand and official seal.

[Stamp or Seal]

Notary Public, State of Hawaii

Print Name

My commission expires: _____

NOTARY PUBLIC CERTIFICATION	
Doc. Date: _____	# Pages: _____
Notary Name: _____	Judicial Circuit: _____
Doc. Description: _____ _____ _____ _____	[Stamp or Seal]
Notary Signature: _____	
Date: _____	

MAUI ECONOMIC DEVELOPMENT BOARD

By _____
(Signature)

Print Name: _____

Its _____
(Title)

By _____
(Signature)

Print Name: _____

Its _____
(Title)

[REMAINDER OF PAGE INTENTIONALLY LEFT BLANK]

STATE OF HAWAII)
) SS.
COUNTY OF MAUI)

On this _____ day of _____, 20____, before me personally appeared _____, to me personally known, who, being by me duly sworn or affirmed, did say that such person executed the foregoing instrument as the free act and deed of such person, and if applicable, in the capacity shown, having been duly authorized to execute such instrument in such capacity.

IN WITNESS WHEREOF, I have hereunto set my hand and official seal.

[Stamp or Seal]

Notary Public, State of Hawaii

Print Name

My commission expires: _____

NOTARY PUBLIC CERTIFICATION	
Doc. Date: _____	# Pages: _____
Notary Name: _____	Judicial Circuit: _____
Doc. Description: _____ _____ _____ _____	[Stamp or Seal]
Notary Signature: _____	
Date: _____	

STATE OF HAWAII)
) SS.
COUNTY OF MAUI)

On this _____ day of _____, 20____, before me personally appeared _____, to me personally known, who, being by me duly sworn or affirmed, did say that such person executed the foregoing instrument as the free act and deed of such person, and if applicable, in the capacity shown, having been duly authorized to execute such instrument in such capacity.

IN WITNESS WHEREOF, I have hereunto set my hand and official seal.

[Stamp or Seal]

Notary Public, State of Hawaii

Print Name

My commission expires: _____

NOTARY PUBLIC CERTIFICATION	
Doc. Date: _____	# Pages: _____
Notary Name: _____	Judicial Circuit: _____
Doc. Description: _____ _____ _____ _____	
[Stamp or Seal]	
Notary Signature: _____	
Date: _____	

COUNTY OF MAUI:

By _____
ALAN M. ARAKAWA
Its Mayor

APPROVAL RECOMMENDED:

TEENA RASMUSSEN
Director, Office of
Economic Development

SANANDA K. BAZ
Budget Director

APPROVED AS TO FORM
AND LEGALITY:



JERRIE L. SHEPPARD
Deputy Corporation Counsel
County of Maui
2016-0312
2018-07-23 1 p.m. Amendment 2 to License Agreement

STATE OF HAWAII)
) SS.
COUNTY OF MAUI)

On this _____ day of _____, 20____, before me appeared **ALAN M. ARAKAWA**, to me personally known, who being by me duly sworn did say that he is the Mayor of the County of Maui, a political subdivision of the State of Hawaii, in the capacity shown, having been duly authorized to execute such instrument in such capacity, and that the seal affixed to the foregoing instrument is the lawful seal of the said County of Maui, and that the said instrument was signed and sealed in behalf of said County of Maui by authority of its Charter, and the said **ALAN M. ARAKAWA** acknowledged the said instrument to be the free act and deed of said County of Maui.

IN WITNESS WHEREOF, I have hereunto set my hand and official seal.

[Stamp or Seal]

Notary Public, State of Hawaii

Print Name: _____

My commission expires: _____

NOTARY PUBLIC CERTIFICATION	
Doc. Date: _____	# Pages: _____
Notary Name: _____	Judicial Circuit: _____
Doc. Description: _____	

[Stamp or Seal]	
Notary Signature: _____	
Date: _____	

1/4" = 1'-0" WITH 1/8" ADD.
 1/8" = 1'-0" WITH 1/8" ADD.

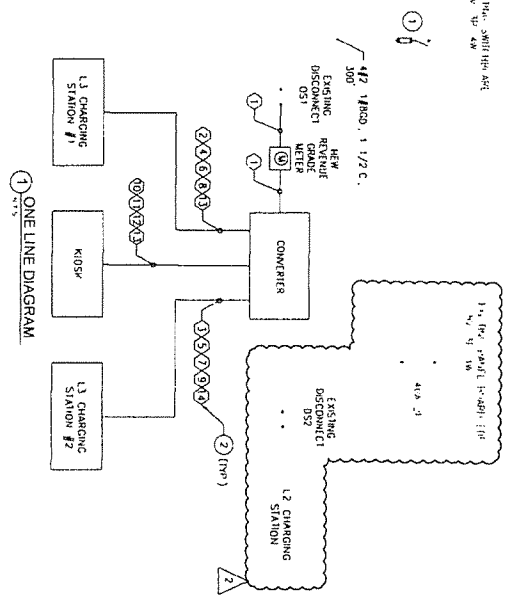

CABLE AND CONDUIT SCHEDULE

CABLE NUMBER	IDENTIFY SIZE	CONDUIT TYPE	CABLE SIZE	FROM	TO	NOTES
1	1/2"	PVC SCH 40	2x2, 2x6x2	CONVERTER BOARD	CONVERTER BOARD TRX2311	
2	1 1/4"	PVC SCH 40	2x1, 2x6x2	CONVERTER BOARD TRX2311	CHARGING STATION #1 TRX1121	DC 500V OUTPUT CABLE
3	1 1/4"	PVC SCH 40	2x1, 2x6x2	CONVERTER BOARD TRX2311	CHARGING STATION #2 TRX1122	DC 500V OUTPUT CABLE
4	3/4"	PVC SCH 40	UTP CAT5e, 492x8	CONVERTER BOARD TRX2311	LAN CONNECTOR #1 TRX2311	
5	3/4"	PVC SCH 40	UTP CAT5e, 492x8	CONVERTER BOARD TRX2311	LAN CONNECTOR #2 TRX2311	
6	3/4"	PVC SCH 40	2x12	CONVERTER BOARD TRX2311	CHARGING STATION #1 TRX2311	AC 200V
7	3/4"	PVC SCH 40	2x12	CONVERTER BOARD TRX2311	CHARGING STATION #2 TRX2311	AC 200V
8	3/4"	PVC SCH 40	2x12	CONVERTER BOARD TRX2311	WARNING SIGNAL V/O TRX2311	
9	1"	PVC SCH 40	2x6x2	CONVERTER BOARD TRX2311	CONVERTER BOARD TRX2311	WARNING SIGNAL V/O
10	3/4"	PVC SCH 40	UTP CAT5e, 492x8	CONVERTER BOARD TRX2311	LAN CONNECTOR #1 TRX2311	
11	3/4"	PVC SCH 40	2x12, 2x6x2	CONVERTER BOARD TRX2311	CONVERTER BOARD TRX2311	
12	3/4"	PVC SCH 40	2x12, 2x6x2	CONVERTER BOARD TRX2311	CONVERTER BOARD TRX2311	
13	3/4"	PVC SCH 40	2x12, 2x6x2	CONVERTER BOARD TRX2311	CONVERTER BOARD TRX2311	
14	3/4"	PVC SCH 40	2x12, 2x6x2	CONVERTER BOARD TRX2311	CONVERTER BOARD TRX2311	
15	3/4"	PVC SCH 40	2x12, 2x6x2	CONVERTER BOARD TRX2311	CONVERTER BOARD TRX2311	

LEGEND
 EXISTING TO BE REVISED
 - - - - - EXISTING TO REMAIN
 - - - - - NEW

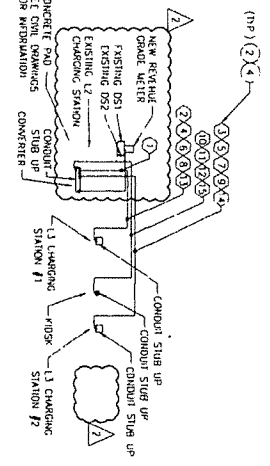

5 PARTIAL SITE PLAN - CHARGING STATION
 SCALE 1/4" = 1'-0"

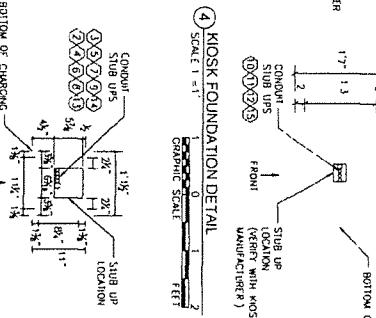
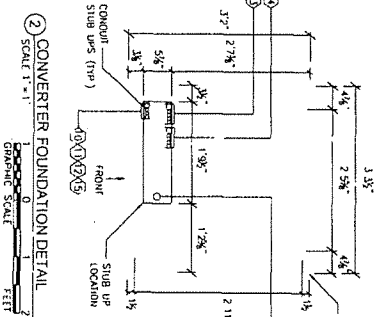

3 CHARGING STATION FOUNDATION DETAIL
 SCALE 1" = 1'-0"

8 KEY NOTES

- 1 REPLACE EXISTING RIGS WITH NEW 3-100A FUSES WITHIN EXISTING SWITCHBOARD
- 2 EQUIPMENT WIRING TAG REFER TO CABLE AND CONDUIT SCHEDULE THIS SHEET FOR INFORMATION
- 3 PROVIDE WATER PROOF SEAL ON BOTH ENDS OF CONDUIT
- 4 ROUTE CONDUITS UNDERGROUND MINIMUM 12" BELOW FINISHED GRADE

EXHIBIT = C

SHEET NO. E001
 OF 3 SHEETS

ONE LINE DIAGRAM FOUNDATION SCHEDULE AND SCHEDULE

REV #	DATE	DESCRIPTION
1	12/21/2024	MEG SUBMITAL
2	12/17/24	AS-BUILT

NEW EV CHARGING STATION FOR WAILUKU COURTHOUSE
 200 S HIGH STREET
 WAILUKU, HI 96793
 TEL: 340680420000



WZ Engineering
 Mechanical Electrical Plumbing Engineering
 1001 KALANANAKU BLVD, SUITE 200, HONOLULU, HI 96813
 TEL: 808-943-8888 FAX: 808-943-8889

HALEAKALA S LAR

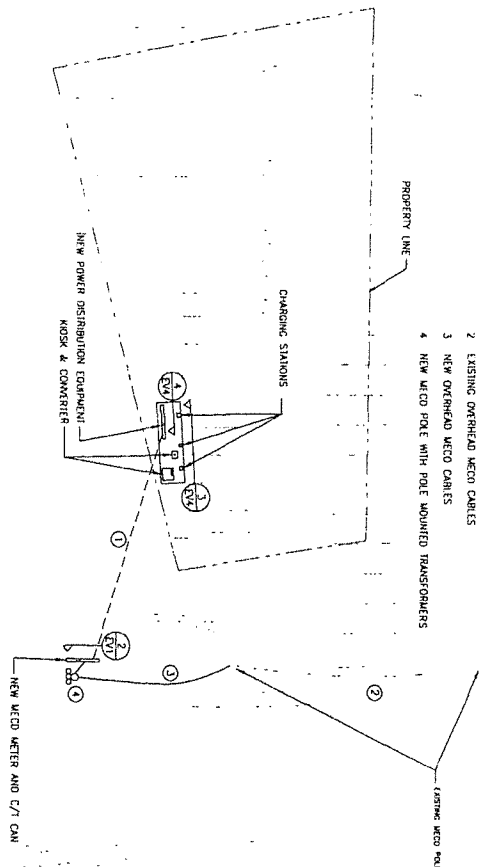

- KEY NOTES**
- 1 DASHED-LINES DENOTES UNDERGROUND SERVICE
 - 2 EXISTING OVERHEAD MECO CARRIES
 - 3 NEW OVERHEAD MECO CARRIES
 - 4 NEW MECO POLE WITH POLE MOUNTED TRANSFORMERS

1 SITE PLAN
SCALE 1/16" = 1'-0"
GRAPHIC SCALE

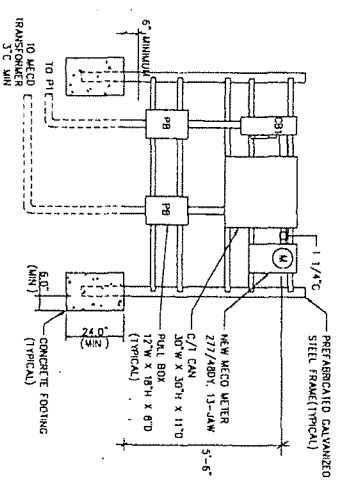

2 ELEVATION - MECO SERVICE
SCALE 1/2" = 1'-0"

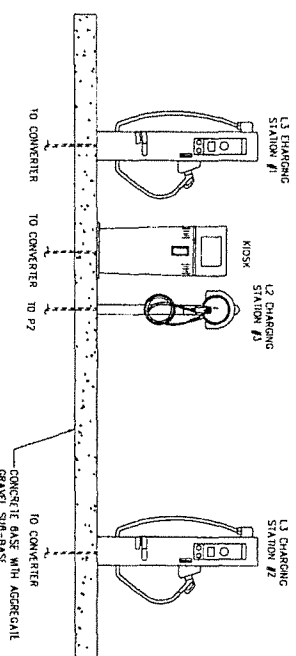

3 ELEVATION - NEW CHARGING STATIONS AND KIOSK
SCALE 1/4" = 1'-0"

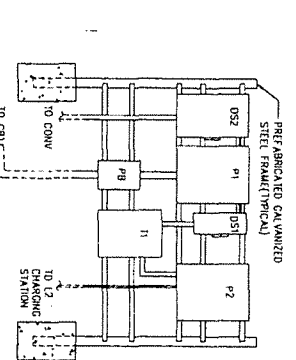

4 ELEVATION - NEW ELECTRICAL SERVICE EQUIPMENT
SCALE 1/4" = 1'-0"

EXHIBIT "D"

SHEET NO. 1 EV1 OF 3 SHEETS	SITE PLAN AND DETAILS	<table border="1"> <thead> <tr> <th>REV</th> <th>DATE</th> <th>DESCRIPTION</th> </tr> </thead> <tbody> <tr> <td>1</td> <td>11/2/2014</td> <td>PERCING SET</td> </tr> <tr> <td>2</td> <td>12/18/15</td> <td>REVISED</td> </tr> <tr> <td>3</td> <td>12/2/2015</td> <td>MECO REVISION</td> </tr> </tbody> </table>	REV	DATE	DESCRIPTION	1	11/2/2014	PERCING SET	2	12/18/15	REVISED	3	12/2/2015	MECO REVISION	NEW EV CHARGING STATION FOR HAIKU COMMUNITY CENTER 0 HANA HIGHWAY HAIKU, HI 96708 TMK 270040290000		WZ Engineering 270 LANA STREET, SUITE 202, HONOLULU, HI 96813 (808) 546-8218 / www.wze-engineering.com	HALEAKALA SOLAR
	REV	DATE	DESCRIPTION															
1	11/2/2014	PERCING SET																
2	12/18/15	REVISED																
3	12/2/2015	MECO REVISION																

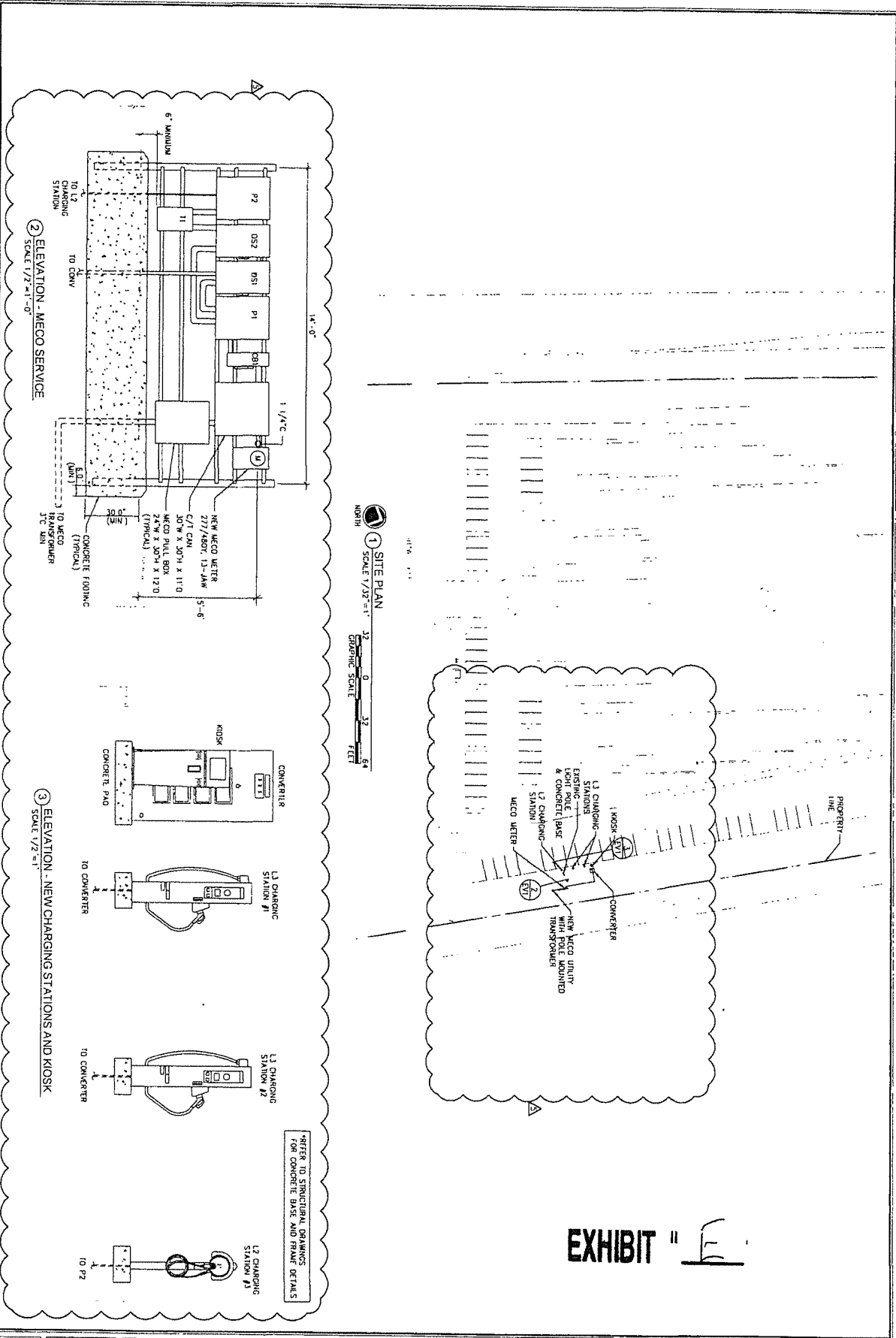

EXHIBIT " F "

SHEET NO. 2 EV1 OF 7 SHEETS	SITE PLANS AND ELEVATIONS	<table border="1"> <thead> <tr> <th>REV #</th> <th>DATE</th> <th>DESCRIPTION</th> </tr> </thead> <tbody> <tr> <td>1</td> <td>12/29/2014</td> <td>PRELIMINARY</td> </tr> <tr> <td>2</td> <td>12/29/2014</td> <td>REVISION</td> </tr> <tr> <td>3</td> <td>12/29/2014</td> <td>REVISION</td> </tr> <tr> <td>4</td> <td>12/29/2014</td> <td>REVISION</td> </tr> <tr> <td>5</td> <td>12/29/2014</td> <td>REVISION</td> </tr> </tbody> </table>	REV #	DATE	DESCRIPTION	1	12/29/2014	PRELIMINARY	2	12/29/2014	REVISION	3	12/29/2014	REVISION	4	12/29/2014	REVISION	5	12/29/2014	REVISION	NEW EV CHARGING STATION FOR: LAHAINA AQUATIC CENTER 245 SHAW STREET TUK 460120050000		WZ Engineering Mechanical, Electrical and Plumbing Engineers 226 Lake Street, 2nd Fl., Kailua, HI 96734 808-258-8118 www.wzengineering.com	HALEAKALA SOLAR
	REV #	DATE	DESCRIPTION																					
1	12/29/2014	PRELIMINARY																						
2	12/29/2014	REVISION																						
3	12/29/2014	REVISION																						
4	12/29/2014	REVISION																						
5	12/29/2014	REVISION																						